

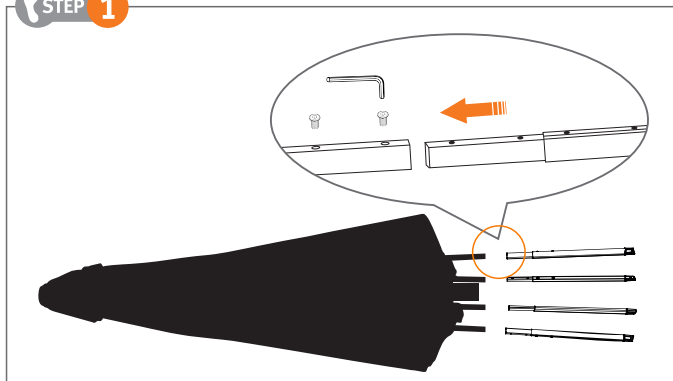

# Santorini

Art.-Nr. 1000-15, 325 x 325 cm

## STEP 1



## STEP 2

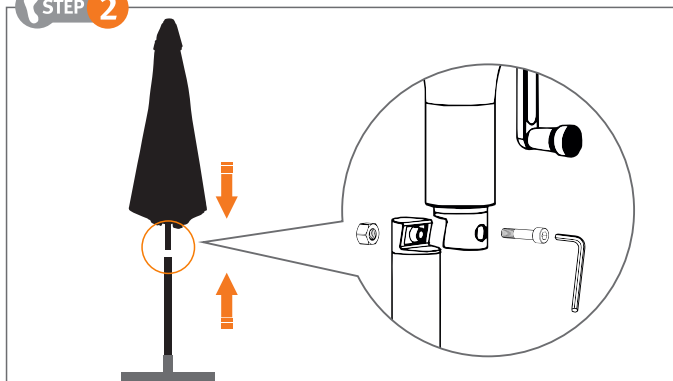

## STEP 3

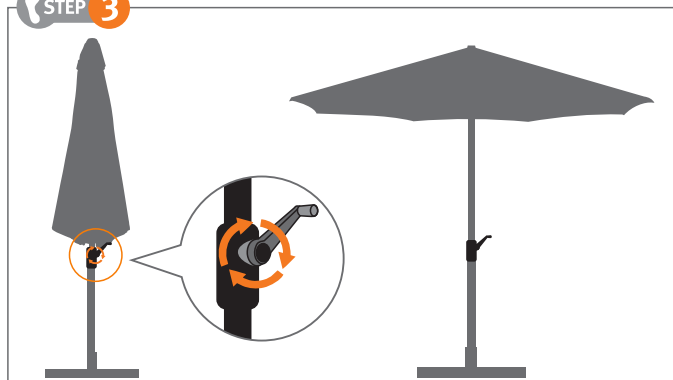

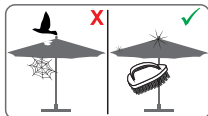
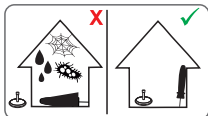
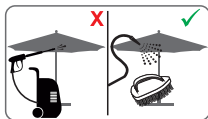
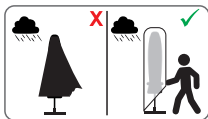

(D) Schirm sicher befestigen, Schirm bei Wind schließen! (BB) Fasten parasol securely, close parasol in windy conditions! (FR) Fixer solidement le parasol, Fermer le parasol en cas de vent!  
 (AL) Ngjithni ombrellën në mënyrë të sigurt dhe mbyllni ombrellën në kushte me erë!  
 (BG) Закрепете чадъра здраво, Затворете чадъра при вятър! (CZ) Slunečník bezpečně upevněte, Při větru slunečník zavřete! (DK) Fastgør parasollen sikkert, luk parasollen i blæsevejr!  
 (EE) Kinnitage päikesevari kindlalt, sulgege päikesevari tuulistes tingimustes! (ES) ¡Fijar el parasol con seguridad! ¡Cerrar el parasol en caso de viento! (FI) Kiinnitä aurinkovarjo tukevasti, sulje aurinkovarjo tuulisissa olosuhteissa! (GB) Στερεώστε καλά την ομπρέλα, Κλείνετε την ομπρέλα όταν φυσάει!  
 (HR) Čvrsto pričvrstite suncobran i zatvorite ga u vjetrovitim uvjetima! (HU) Biztosan rögzítse az ernyőt, Szélben csukja össze az ernyőt! (IT) Fissare bene l'ombrellone! Chiudere l'ombrellone in caso di vento! (LT) Saugiai pritvirtinkite apsauginį skydelį nuo saulės, esant vėjuiotam orui uždarykite apsauginį skydelį nuo saulės!  
 (LV) Droši nostipriniet saulesargu, vējainā laikā saulesargu aizveriet! (NL) Paraplu veilig bevestigen, Paraplu bij wind sluiten! (NO) Fest parasollen godt, og lukk parasollen når det blåser! (PL) Parasol zamocować bezpiecznie, Parasol podczas wiatru zamknąć! (PT) Fixar o guarda-sol de forma segura! Fechar o guarda-sol quando levantar vento! (RO) Umbrela se fixează ferm, închideți umbrela în cazul în care este vânt!  
 (RS) Чврсто причврстите сунцобран и затворите сунцобран у ветровитим условима! (SE) Fäst parasollet ordentligt, stäng parasollet i blåsiga förhållanden! (SI) Varno pritrdite senčnik, v vetrovnih razmerah ga zaprite!  
 (SK) Bezpečně upevnenie slnečníka, Pri veternom počasí uzavrite slnečník! (TR) Şemsiyeyi güvenli bir şekilde sabitleyin, rüzgarlı havalarda kapatın! (UA) Надійно закріплюйте парасольку, закривайте парасольку у вітряну погоду!

